



Half Controlled Single Phase Rectifier Bridge with Freewheeling Diode

$$I_{dAVM} = 40 \text{ A}$$

$$V_{RRM} = 800-1600 \text{ V}$$

Part numbers

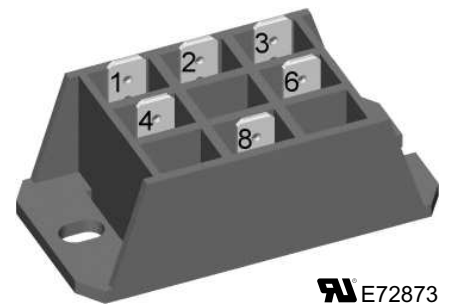
V_{RSM}	V_{RRM}	Type
V_{DSM}	V_{DRM}	
V	V	
900	800	VHF 36-08io5
1300	1200	VHF 36-12io5
1700	1600	VHF 36-16io5

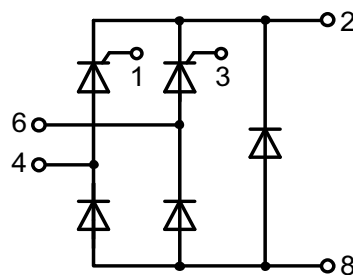
 E72873

Features / Advantages:

- Planar passivated chips
- Space and weight savings
- Improved temperature & power cycling

Applications:

- Supply for DC power equipment
- DC motor control

Package: FO-F

- Isolation Voltage: 3600 V~
- DCB ceramic base plate
- 1/4" fast-on terminals
- Easy to mount with two screws
- RoHS compliant

Disclaimer Notice

Information furnished is believed to be accurate and reliable. However, users should independently evaluate the suitability of and test each product selected for their own applications. Littelfuse products are not designed for, and may not be used in, all applications. Read complete Disclaimer Notice at www.littelfuse.com/disclaimer-electronics.

Diodes				Ratings			
Symbol	Definitions	Conditions	min.	typ.	max.	Unit	
I_{dAV}	average DC output current	module			36	A	
I_{dAVM}	max. average DC output current	for resistive load			40	A	
I_{FRMS}, I_{TRMS}	RMS forward current	per leg			28	A	
I_{FSM}, I_{TSM}	max. surge forward current	$t = 10\text{ ms (50 Hz), sine}$ $t = 8.3\text{ ms (60 Hz), sine; } V_R = 0\text{ V}$	$T_{VJ} = 45^\circ\text{C}$		320 350	A A	
		$t = 10\text{ ms (50 Hz), sine}$ $t = 8.3\text{ ms (60 Hz), sine; } V_R = 0\text{ V}$	$T_{VJ} = 125^\circ\text{C}$		280 310	A A	
I^2t	I^2t value for fusing	$t = 10\text{ ms (50 Hz), sine}$ $t = 8.3\text{ ms (60 Hz), sine; } V_R = 0\text{ V}$	$T_{VJ} = 45^\circ\text{C}$		500 520	A ² s A ² s	
		$t = 10\text{ ms (50 Hz), sine}$ $t = 8.3\text{ ms (60 Hz), sine; } V_R = 0\text{ V}$	$T_{VJ} = 125^\circ\text{C}$		390 400	A ² s A ² s	
$(di/dt)_{cr}$	critical rate of rise of current	$f = 50\text{ Hz, } t_p = 200\text{ }\mu\text{s, } V_D = 2/3 V_{DRM}$ $I_G = 0.3\text{ A, } di_G/dt = 0.3\text{ A}/\mu\text{s}$	$T_{VJ} = 125^\circ\text{C}$				
		repetitive, $I_T = 50\text{ A}$ non repetitive, $I_T = 1/2 I_{dAV}$			150 500	A/ μs A/ μs	
$(dv/dt)_{cr}$	critical rate of rise of voltage	$V_D = 2/3 V_{DRM}$ $R_{GK} = \infty$; method 1 (linear voltage rise)	$T_{VJ} = 125^\circ\text{C}$		1000	V/ μs	
V_{RGM}	max. reverse gate voltage				10	V	
P_{GM}	max. gate power dissipation	$I_T = I_{TAVM}$ $t_p = 30\text{ }\mu\text{s}$ $t_p = 500\text{ }\mu\text{s}$ $t_p = 10\text{ ms}$	$T_{VJ} = 125^\circ\text{C}$		10 5 1	W W W	
P_{GAVM}	max. average gate power dissipation				0.5	W	

Thyristors				Ratings			
Symbol	Definitions	Conditions	min.	typ.	max.	Unit	
I_R, I_D	reverse, drain current	$V_R = V_{RRM}; V_D = V_{DRM}$	$T_{VJ} = 25^\circ\text{C}$ $T_{VJ} = 125^\circ\text{C}$		0.3 5	mA mA	
V_T, V_F	forward voltage	$I_T, I_F = 45\text{ A}$	$T_{VJ} = 25^\circ\text{C}$		1.45	V	
V_{TO}		For power-loss calculations only	$T_{VJ} = 125^\circ\text{C}$	0.85		V	
r_T				13		m Ω	
V_{GT}	gate trigger voltage	$V_D = 6\text{ V}$	$T_{VJ} = 25^\circ\text{C}$ $T_{VJ} = -40^\circ\text{C}$		1.0 1.2	V V	
I_{GT}	gate trigger current	$V_D = 6\text{ V}$	$T_{VJ} = 25^\circ\text{C}$ $T_{VJ} = -40^\circ\text{C}$ $T_{VJ} = 125^\circ\text{C}$		65 80 50	mA mA mA	
V_{GD}	gate non-trigger voltage	$V_D = 2/3 V_{DRM}$	$T_{VJ} = 125^\circ\text{C}$		0.2	V	
I_{GD}	non-trigger gate current				5	mA	
I_L	latching current	$I_G = 0.3\text{ A, } t_G = 30\text{ }\mu\text{s}$ $di_G/dt = 0.3\text{ A}/\mu\text{s}$	$T_{VJ} = 25^\circ\text{C}$ $T_{VJ} = -40^\circ\text{C}$ $T_{VJ} = 125^\circ\text{C}$		150 200 100	mA mA mA	
I_H	holding current	$V_D = 6\text{ V, } R_{GK} = \infty$	$T_{VJ} = 25^\circ\text{C}$		100	ns	
t_{gd}	gate controlled delay time	$V_D = 1/2 V_{DRM}$ $I_G = 0.3\text{ A, } di_G/dt = 0.3\text{ A}/\mu\text{s}$	$T_{VJ} = 25^\circ\text{C}$	2		μs	
t_{ri}	turn-off time	$I_T = 15\text{ A, } t_p = 300\text{ }\mu\text{s, } V_R = 100\text{ V; } T_{VJ} = 125^\circ\text{C}$		150		μs	
Q_r	reverse recovery charge	$di/dt = -10\text{ A}/\mu\text{s, } dv/dt = 20\text{ V}/\mu\text{s, } V_D = 2/3 V_{DRM}$		75		μC	
R_{thJC}	thermal resistance junction to case	per thyristor (diode); DC current per module			1.15 0.29	K/W K/W	
R_{thJH}	thermal resistance junction to heatsink	per thyristor (diode); DC current per module			1.55 0.39	K/W K/W	

Data according to IEC 60747 and refer to a single thyristor/diode unless otherwise stated.

IXYS reserves the right to change limits, test conditions and dimensions.

20191217a



Package FO-F				Ratings		
Symbol	Definitions	Conditions	min.	typ.	max.	Unit
I_{RMS}	RMS current	per terminal			100	A
T_{VJ}	virtual junction temperature		-40		125	°C
T_{op}	operation temperature		-40		100	°C
T_{stg}	storage temperature		-40		125	°C
Weight				45		g
M_D	mounting torque		2		2.5	Nm
$d_{Spp/App}$	creepage distance on surface / striking distance through air	terminal to terminal	18.0	6.0		mm
$d_{Spb/Apb}$		terminal to backside	26.0	20.0		mm
V_{ISOL}	isolation voltage	t = 1 second	50/60 Hz, RMS, $I_{ISOL} \leq 1$ mA	3600		V
		t = 1 minute		3000		V

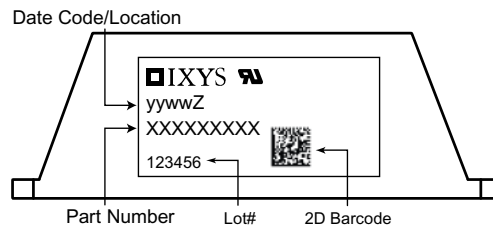

Dimensions in mm (1 mm = 0.0394")

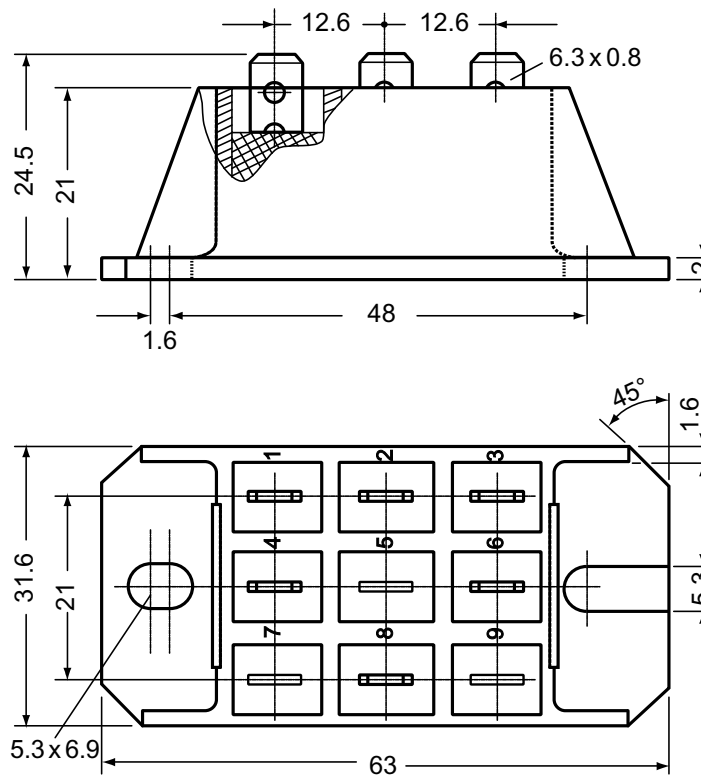

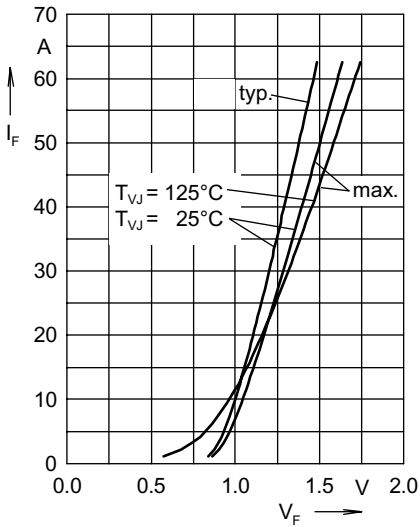

Fig. 3 Forward current versus voltage drop per diode

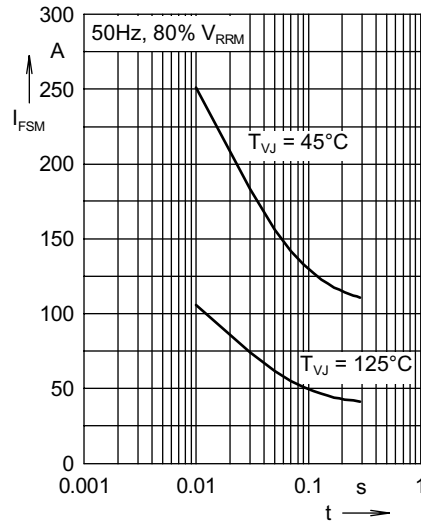

Fig. 4 Surge overload current

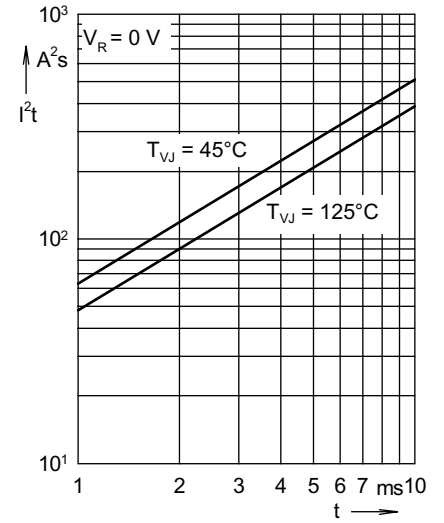

Fig. 5 I^2t versus time per diode

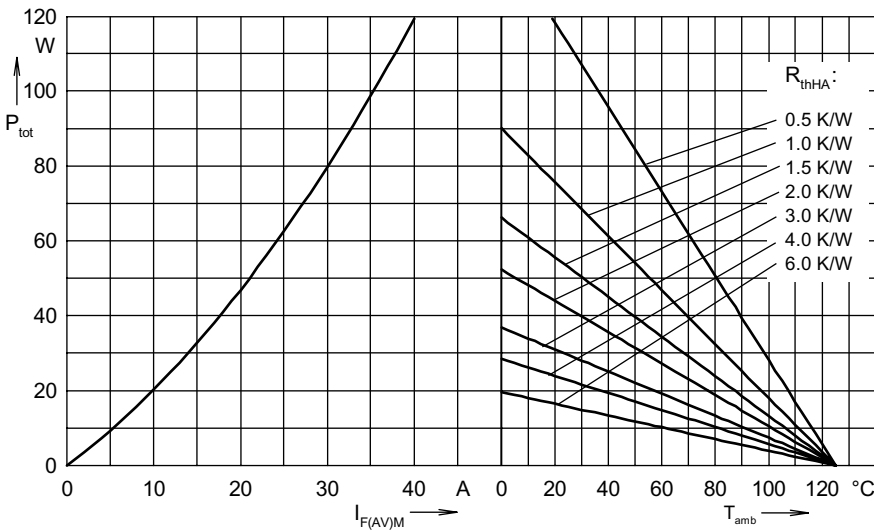

Fig. 6 Power dissipation versus direct output current and ambient temperature

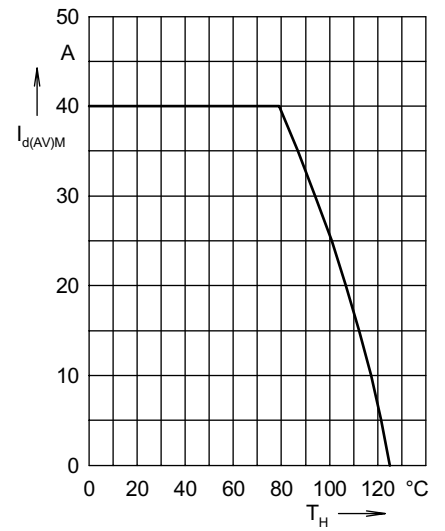

Fig. 7 Max. forward current versus heatsink temperature

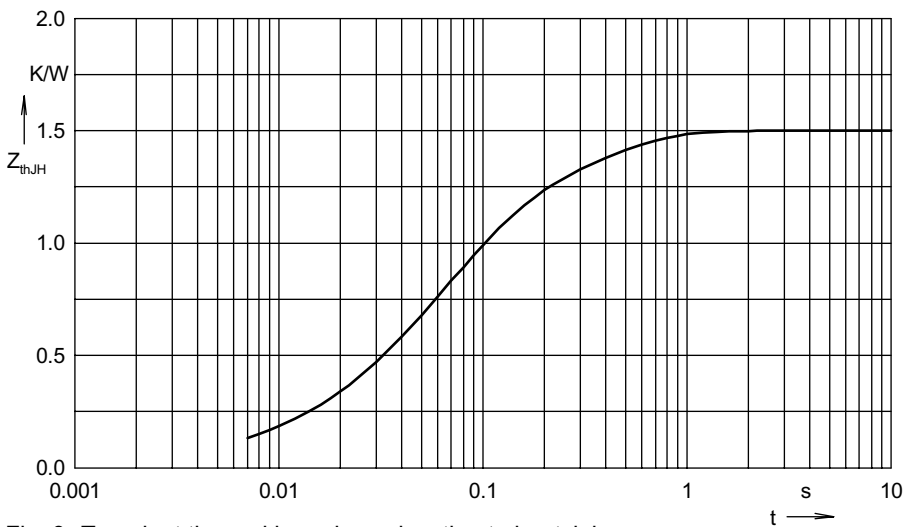

Fig. 8 Transient thermal impedance junction to heatsink

Constants for Z_{thJH} calculation:

i	R_{thi} (K/W)	t_i (s)
1	0.005	0.008
2	0.2	0.05
3	0.875	0.06
4	0.47	0.25