

Six-Pack SPT+ IGBT

$V_{CES} = 1200\text{ V}$

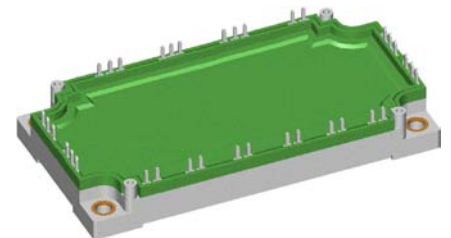
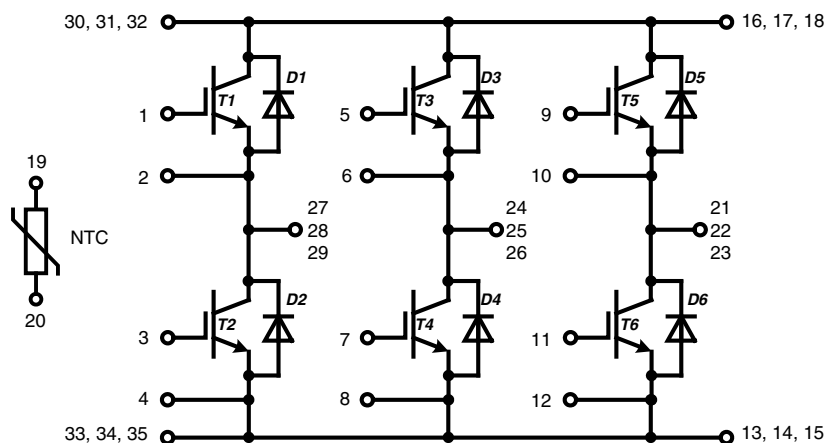
$I_{C25} = 170\text{ A}$

$V_{CE(sat) typ.} = 1.9\text{ V}$

Preliminary data

Part name (Marking on product)

MIEB100W1200DPFTEH



E 72873

Features:

- SPT+ IGBT technology
- low saturation voltage
- low switching losses
- switching frequency up to 30 kHz
- square RBSOA, no latch up
- high short circuit capability
- positive temperature coefficient for easy paralleling
- MOS input, voltage controlled
- ultra fast free wheeling diodes
- solderable pins for PCB mounting
- space savings
- HiPerFRED™ diode

Application:

- AC motor control
- AC servo and robot drives
- power supplies

Package:

- designed for wave soldering
- with copper base plate

Output Inverter T1 - T6

Symbol	Definitions	Conditions	Ratings			Unit	
			min.	typ.	max.		
V_{CES}	collector emitter voltage		$T_{VJ} = 25^{\circ}\text{C}$		1200	V	
V_{GES}	max. DC gate voltage	continuous			± 20	V	
V_{GEM}	max. transient collector gate voltage	transient			± 30	V	
I_{C25}	collector current		$T_C = 25^{\circ}\text{C}$		171	A	
I_{C80}			$T_C = 80^{\circ}\text{C}$		119	A	
P_{tot}	total power dissipation		$T_C = 25^{\circ}\text{C}$		600	W	
$V_{CE(sat)}$	collector emitter saturation voltage (on chip level) ①	$I_C = 100\text{ A}; V_{GE} = 15\text{ V}$	$T_{VJ} = 25^{\circ}\text{C}$ $T_{VJ} = 125^{\circ}\text{C}$	1.9 2.1	2.3 2.5	V V	
$V_{GE(th)}$	gate emitter threshold voltage	$I_C = 4\text{ mA}; V_{GE} = V_{CE}$	$T_{VJ} = 25^{\circ}\text{C}$	5	6	7	V
I_{CES}	collector emitter leakage current	$V_{CE} = V_{CES}; V_{GE} = 0\text{ V}$	$T_{VJ} = 25^{\circ}\text{C}$ $T_{VJ} = 125^{\circ}\text{C}$		1.4 6	mA mA	
I_{GES}	gate emitter leakage current	$V_{GE} = \pm 20\text{ V}$			1	μA	
C_{ies}	input capacitance	$V_{CE} = 25\text{ V}; V_{GE} = 0\text{ V}; f = 1\text{ MHz}$		7430		pF	
$Q_{G(on)}$	total gate charge	$V_{CE} = 600\text{ V}; V_{GE} = 15\text{ V}; I_C = 100\text{ A}$		750		nC	
$t_{d(on)}$	turn-on delay time	inductive load $V_{CE} = 600\text{ V}; I_C = 100\text{ A}$ $V_{GE} = \pm 15\text{ V}; R_G = 10\ \Omega$ $L_S = 70\text{ nH}$	$T_{VJ} = 125^{\circ}\text{C}$	120		ns	
t_r	current rise time			60		ns	
$t_{d(off)}$	turn-off delay time			480		ns	
t_f	current fall time			240		ns	
E_{on}	turn-on energy per pulse			12		mJ	
E_{off}	turn-off energy per pulse			10		mJ	
$E_{rec(off)}$	reverse recovery losses at turn-off	6		mJ			
RBSOA	reverse bias safe operating area	$V_{GE} = \pm 15\text{ V}; R_G = 10\ \Omega;$	$T_{VJ} = 125^{\circ}\text{C}$ $V_{CEK} = 1200\text{ V}$		200	A	
SCSOA	short circuit safe operating area						
t_{SC}	short circuit duration short circuit current	$V_{CE} = 900\text{ V}; V_{GE} = \pm 10\text{ V};$ $R_G = 3.9\ \Omega;$ non-repetitive	$T_{VJ} = 125^{\circ}\text{C}$		10	μs	
R_{thJC}	thermal resistance junction to case	(per IGBT)		0.27	0.21	K/W	
R_{thJH}	thermal resistance junction to heatsink	(IXYS test setup)			0.37	K/W	

Output Inverter D1 - D6

Symbol	Definitions	Conditions	Ratings			Unit
			min.	typ.	max.	
V_{RRM}	max. repetitive reverse voltage		$T_{VJ} = 25^{\circ}\text{C}$		1200	V
I_{F25}	forward current		$T_C = 25^{\circ}\text{C}$		199	A
I_{F80}			$T_C = 80^{\circ}\text{C}$		127	A
V_F	forward voltage (on chip level) ①	$I_F = 100\text{ A}; V_{GE} = 0\text{ V}$	$T_{VJ} = 25^{\circ}\text{C}$ $T_{VJ} = 125^{\circ}\text{C}$		2.5 1.8	V V
I_{rr}	max. reverse recovery current	inductive load $V_{CE} = 600\text{ V}; I_C = 100\text{ A}$ $V_{GE} = \pm 15\text{ V}; R_G = 10\ \Omega$ $L_S = 70\text{ nH}; -di/dt = 2300\text{ A}/\mu\text{s}$	$T_{VJ} = 125^{\circ}\text{C}$	165		A
t_{rr}	reverse recovery time			290		ns
Q_{rr}				18.6		μC
E_{rec}				6		mJ
R_{thJC}	thermal resistance junction to case	(per diode)		0.39	0.3	K/W
R_{thJH}	thermal resistance junction to heatsink	(IXYS test setup)			0.45	K/W

 $T_C = 25^{\circ}\text{C}$ unless otherwise stated

Temperature Sensor NTC

Symbol	Definitions	Conditions	Ratings			Unit
			min.	typ.	max.	
R_{25}	resistance	$T_C = 25^\circ\text{C}$	4.75	5.0	5.25	k Ω
$B_{25/50}$				3375		K

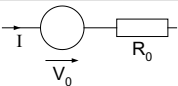
Module

Symbol	Definitions	Conditions	Ratings			Unit
			min.	typ.	max.	
T_{VJ}	operating temperature		-40		125	$^\circ\text{C}$
T_{VJM}	max. virtual junction temperature				150	$^\circ\text{C}$
T_{stg}	storage temperature		-40		125	$^\circ\text{C}$
V_{ISOL}	isolation voltage	$I_{ISOL} \leq 1 \text{ mA}; 50/60 \text{ Hz}$	$t = 1 \text{ min}$ $t = 1 \text{ s}$		3000 3600	V~ V~
CTI	comparative tracking index				200	
M_d	mounting torque (M5)		3		6	Nm
$R_{\text{pin to chip}}$	see ①			2.5		m Ω
d_S	creep distance on surface		12.7			mm
d_A	strike distance through air		9.6			mm
Weight				300		g

① $V_{CE} = V_{CE(sat)} + 2x R_{\text{pin to chip}} \cdot I_C$

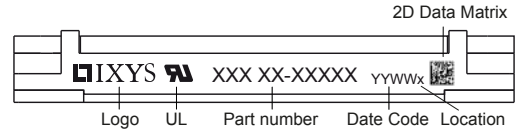
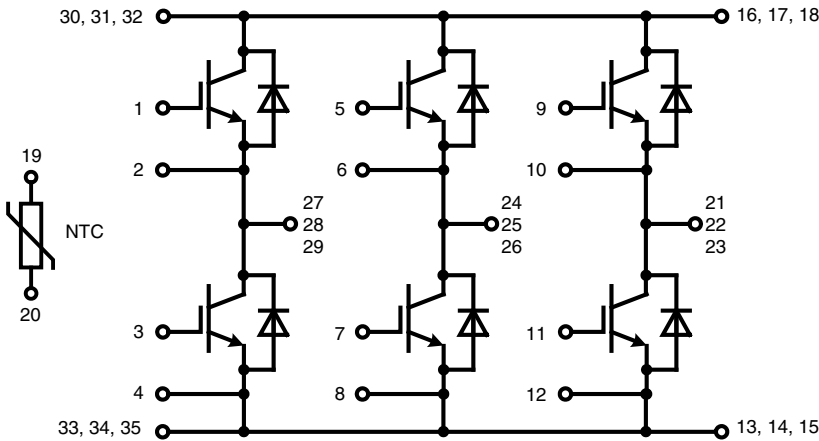
$T_C = 25^\circ\text{C}$ unless otherwise stated

Curves are measured on modul level except Fig. 14 to Fig. 17

Equivalent Circuits for Simulation


Symbol	Definitions	Conditions	Ratings			Unit
			min.	typ.	max.	
V_0	IGBT	T1 - T6	$T_{VJ} = 150^\circ\text{C}$		1.25	V
R_0					13	m Ω
V_0	free wheeling diode	D1 - D6	$T_{VJ} = 150^\circ\text{C}$		1.40	V
R_0					3.5	m Ω

Circuit Diagram

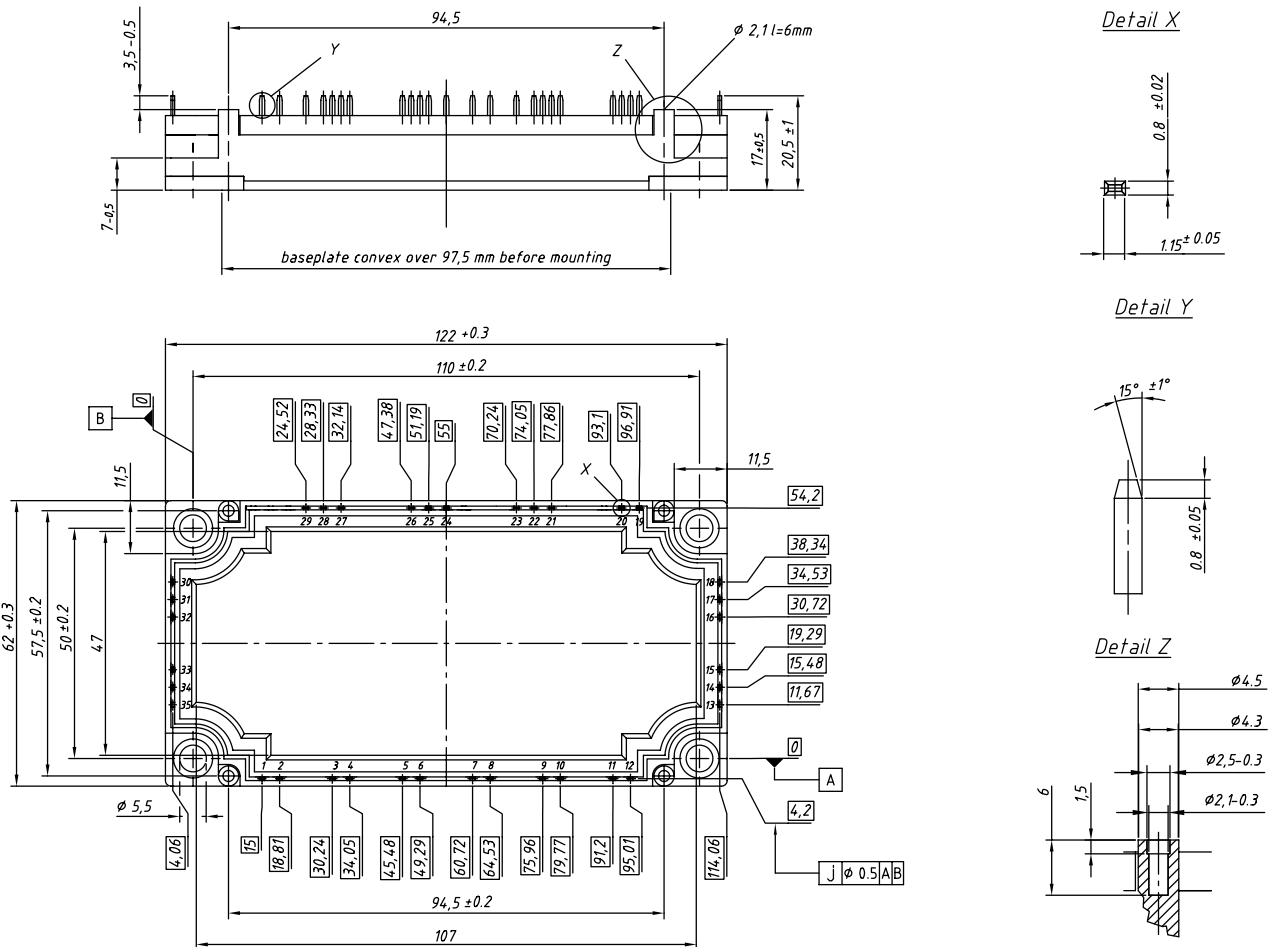


Part number

- M = Module
- I = IGBT
- X = XPT
- A = standard
- 150 = Current Rating [A]
- W = Six-Pack
- 1200 = Reverse Voltage [V]
- T = NTC
- EH = E3-Pack

Outline Drawing

Dimensions in mm (1 mm = 0.0394")



Product Marking

Ordering	Part Name	Marking on Product	Delivering Mode	Base Qty	Ordering Code
Standard	MIEB100W1200DPFTEH	MIEB100W1200DPFTEH	Box	5	511348

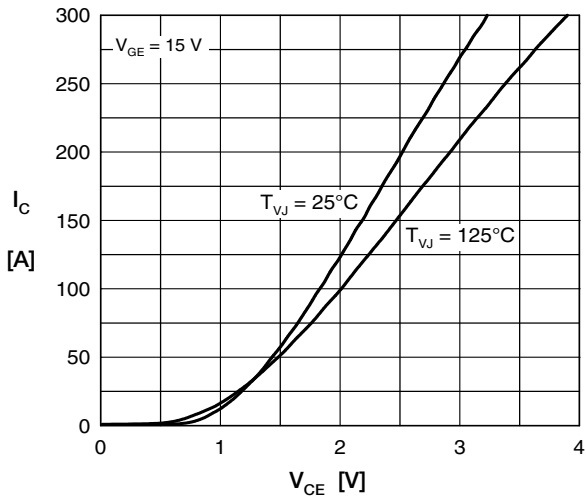
Output Inverter IGBT


Fig. 1 Typ. output characteristics

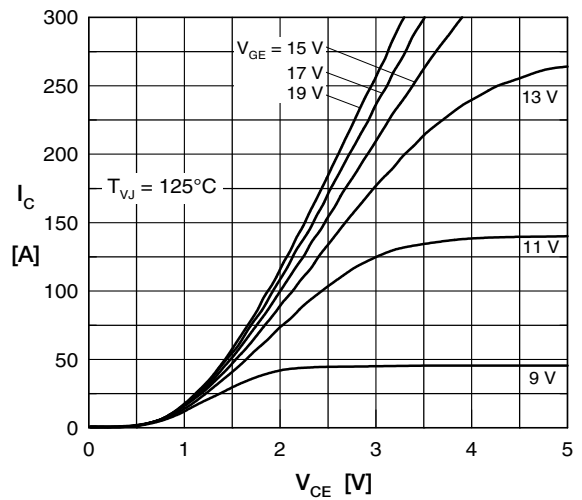


Fig. 2 Typ. output characteristics

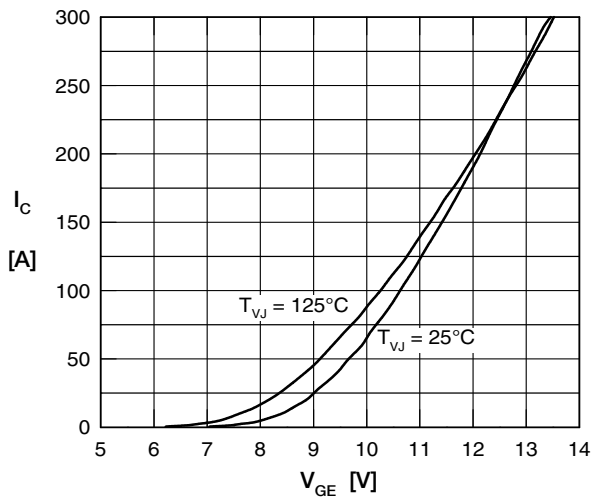


Fig. 3 Typ. transfer characteristics

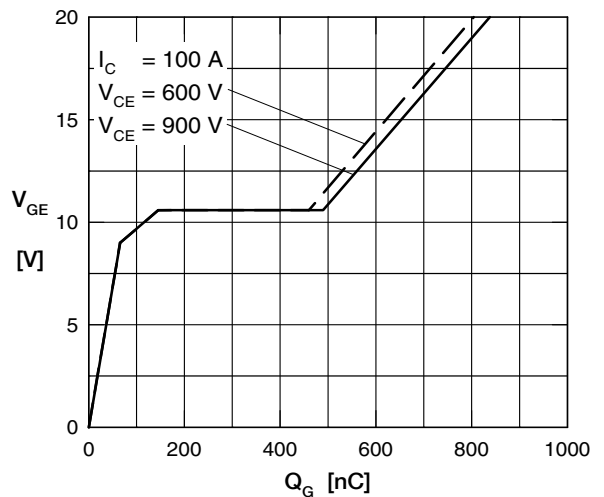


Fig. 4 Typ. turn-on gate charge

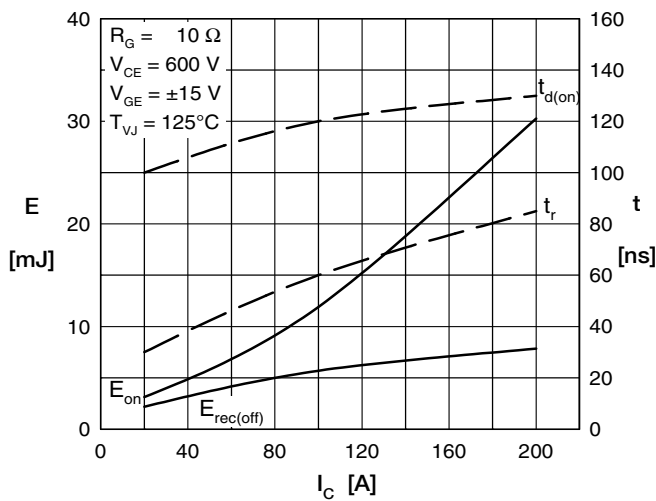


Fig. 5 Typ. turn-on energy & switching times versus collector current

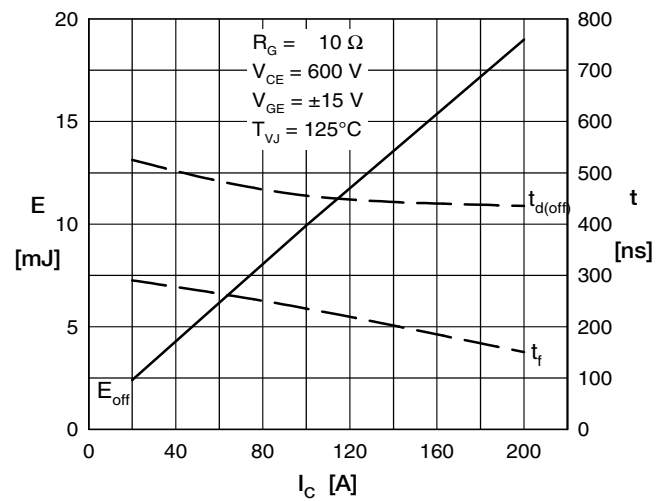


Fig. 6 Typ. turn-off energy & switching times versus collector current

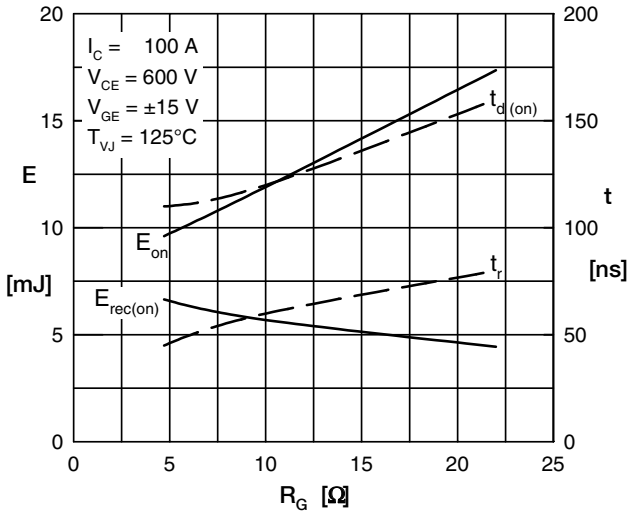
Output Inverter IGBT


Fig. 7 Typ. turn-on energy and switching times versus gate resistor

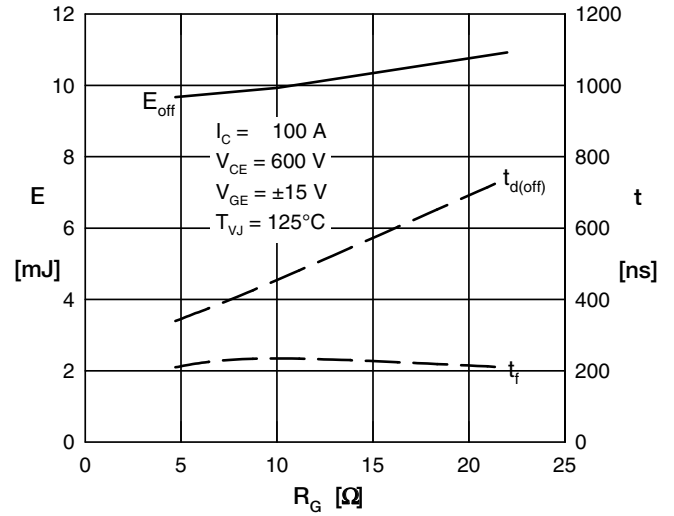


Fig. 8 Typ. turn-off energy and switching times versus gate resistor

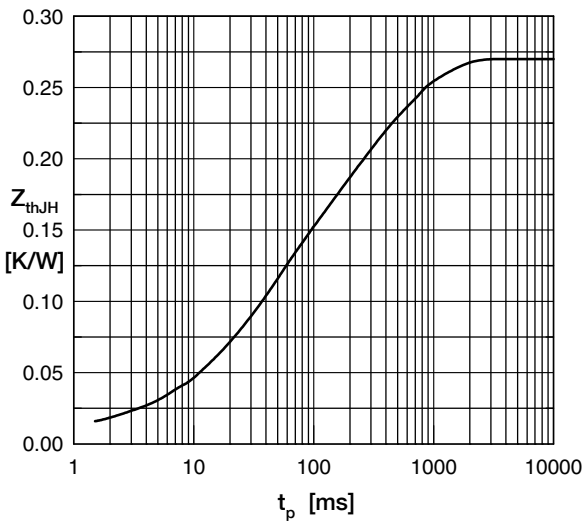


Fig. 9 Typ. transient thermal impedance

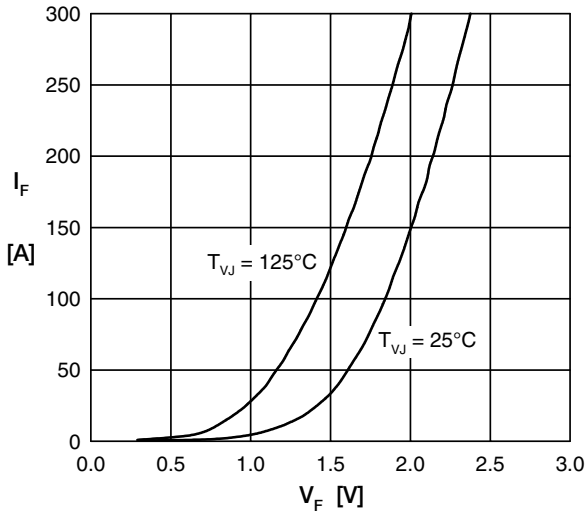
Output Inverter Diode


Fig. 10 Typ. forward characteristics

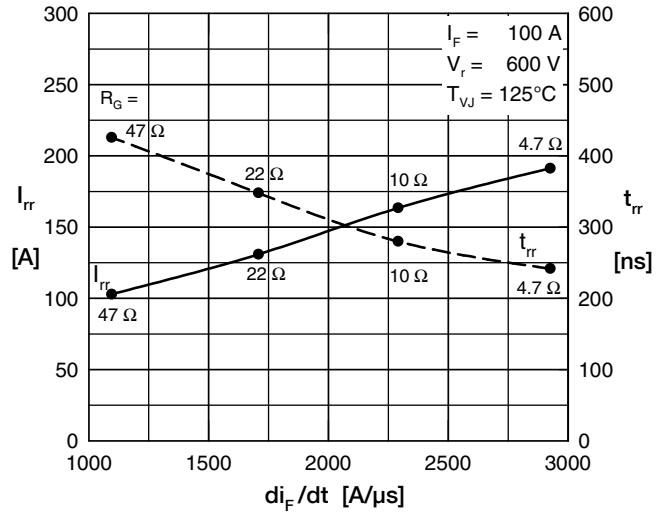


Fig. 11 Typ. reverse recovery characteristics

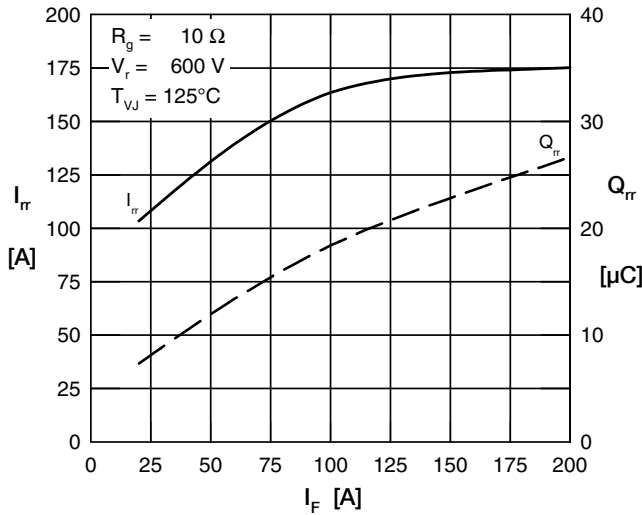


Fig. 12 Typ. reverse recovery characteristics

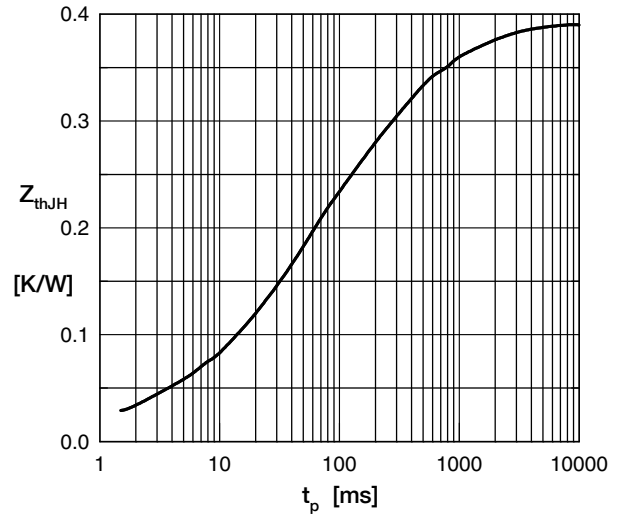


Fig. 13 Typ. transient thermal impedance