

# IGBT phaseleg

in ISOPLUS i4-PAC™

$I_{C25} = 40 \text{ A}$   
 $V_{CES} = 600 \text{ V}$   
 $V_{CE(sat) \text{ typ.}} = 1.8 \text{ V}$

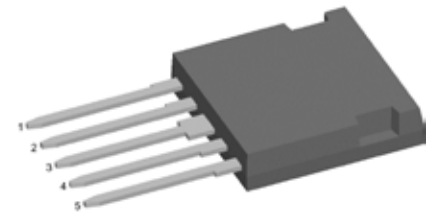
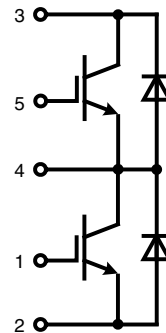

E72873

IGBT					
Symbol	Conditions	Maximum Ratings			
$V_{CES}$	$T_{VJ} = 25^{\circ}\text{C to } 150^{\circ}\text{C}$	600	V		
$V_{GES}$		$\pm 20$	V		
$I_{C25}$	$T_C = 25^{\circ}\text{C}$	40	A		
$I_{C90}$	$T_C = 90^{\circ}\text{C}$	25	A		
$I_{CM}$	$V_{GE} = \pm 15 \text{ V}; R_G = 33 \Omega; T_{VJ} = 125^{\circ}\text{C}$	60	A		
$V_{CEK}$	<b>RBSOA</b> Clamped inductive load; $L = 100 \mu\text{H}$	$V_{CES}$			
$t_{SC}$ (SCSOA)	$V_{CE} = V_{CES}; V_{GE} = \pm 15 \text{ V}; R_G = 33 \Omega$ $T_{VJ} = 125^{\circ}\text{C}; \text{non-repetitive}$	10	$\mu\text{s}$		
$P_{tot}$	$T_C = 25^{\circ}\text{C}$	125	W		
Symbol	Conditions	Characteristic Values			
( $T_{VJ} = 25^{\circ}\text{C}$ , unless otherwise specified)					
		min.	typ.	max.	
$V_{CE(sat)}$	$I_C = 25 \text{ A}; V_{GE} = 15 \text{ V}$		1.8	2.2	V
			2.0		V
$V_{GE(th)}$	$I_C = 0.7 \text{ mA}; V_{GE} = V_{CE}$	4.5		6.5	V
$I_{CES}$	$V_{CE} = V_{CES}; V_{GE} = 0 \text{ V}$		0.6	0.6	mA
					mA
$I_{GES}$	$V_{CE} = 0 \text{ V}; V_{GE} = \pm 20 \text{ V}$			200	nA
$t_{d(on)}$	Inductive load $V_{CE} = 300 \text{ V}; I_C = 25 \text{ A}$ $V_{GE} = \pm 15 \text{ V}; R_G = 33 \Omega$ $T_{VJ} = 125^{\circ}\text{C}$		50		ns
$t_r$			50		ns
$t_{d(off)}$			270		ns
$t_f$			40		ns
$E_{on}$			1.2		mJ
$E_{off}$			0.8		mJ
$C_{ies}$	$V_{CE} = 25 \text{ V}; V_{GE} = 0 \text{ V}; f = 1 \text{ MHz}$		1.6		nF
$Q_{Gon}$	$V_{CE} = 300 \text{ V}; V_{GE} = 15 \text{ V}; I_C = 30 \text{ A}$		95		nC
$R_{thJC}$				1	K/W
$R_{thJH}$	with heatsink compound		2		K/W

### Features

- NPT IGBT technology
- low saturation voltage
- positive temperature coefficient for easy paralleling
- fast switching
- HiPerFRED™ diode
- optimized fast and soft reverse recovery
- low operating forward voltage
- low leakage current
- ISOPLUS i4-PAC™ package
- isolated back surface
- low coupling capacity between pins and heatsink
- enlarged creepage towards heatsink
- application friendly pinout
- low inductive current path
- high reliability
- industry standard outline
- UL registered E 72873

### Applications

- single phaseleg
- buck-boost chopper
- H bridge
- power supplies
- induction heating
- four quadrant DC drives
- controlled rectifier
- three phase bridge
- AC drives
- controlled rectifier

Diode						
Symbol	Conditions		Maximum Ratings			
$V_{RRM}$	$T_{VJ} = 25^{\circ}\text{C}$ to $150^{\circ}\text{C}$		600	V		
$I_{F25}$	$T_C = 25^{\circ}\text{C}$		30	A		
$I_{F90}$	$T_C = 90^{\circ}\text{C}$		15	A		
Symbol	Conditions		Characteristic Values			
			min.	typ.	max.	
$V_F$	$I_F = 25\text{ A}$	$T_{VJ} = 25^{\circ}\text{C}$		2.5	2.8	V
		$T_{VJ} = 125^{\circ}\text{C}$		1.7		V
$I_{RM}$ $t_{rr}$	} $I_F = 15\text{ A}; di_F/dt = -400\text{ A}/\mu\text{s};$ $V_R = 300\text{ V}; V_{GE} = 0\text{ V};$	$T_{VJ} = 125^{\circ}\text{C}$		7		A
				50		ns
$R_{thJC}$	(per diode)				2.3	K/W
$R_{thJH}$	with heatsink compound			4.6		K/W

Component						
Symbol	Conditions		Maximum Ratings			
$T_{VJ}$	operating		-55...+150	$^{\circ}\text{C}$		
$T_{stg}$			-55...+125	$^{\circ}\text{C}$		
$V_{ISOL}$	$I_{ISOL} \leq 1\text{ mA}; 50/60\text{ Hz}; t = 1\text{ s}$		2500	V~		
$F_C$	Mounting force with clip		20...120	Nm		
Symbol	Conditions		Characteristic Values			
			min.	typ.	max.	
$C_P$	coupling capacity between shorted pins and mounting tab in the case			40		pF
$d_S, d_A$	pin - pin		1.7			mm
$d_S, d_A$	pin - backside metal		5.5			mm
Weight				6		g

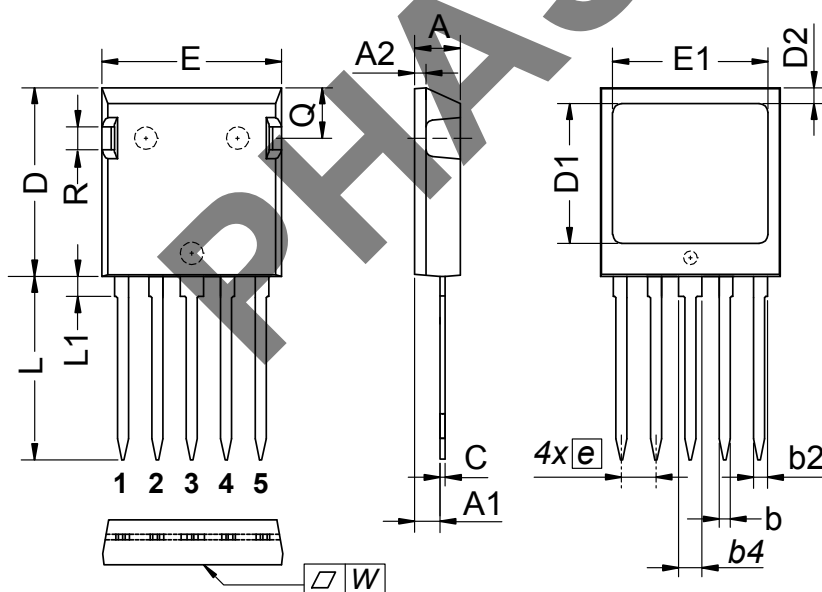

DIM.	MILLIMETER		INCHES	
	MIN	MAX	MIN	MAX
A	4.83	5.21	0.190	0.205
A1	2.59	3.00	0.102	0.118
A2	1.17	2.16	0.046	0.085
b	1.14	1.40	0.045	0.055
b2	1.47	1.73	0.058	0.068
b4	2.54	2.79	0.100	0.110
C	0.51	0.74	0.020	0.029
D	20.80	21.34	0.819	0.840
D1	14.99	15.75	0.590	0.620
D2	1.65	2.03	0.065	0.080
E	19.56	20.29	0.770	0.799
E1	16.76	17.53	0.660	0.690
e	3.81 BSC		0.15 BSC	
L	19.81	21.34	0.780	0.840
L1	2.11	2.59	0.083	0.102
Q	5.33	6.20	0.210	0.244
R	2.54	4.57	0.100	0.180
W	—	0.10	—	0.004

Die konvexe Form des Substrates ist typ. < 0.05 mm über der Kunststoffoberfläche der Bauteilunterseite  
The convex bow of substrate is typ. < 0.05 mm over plastic surface level of device bottom side

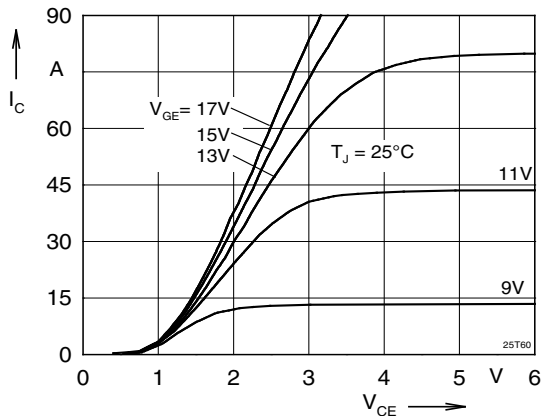

Fig. 1 Typ. output characteristics

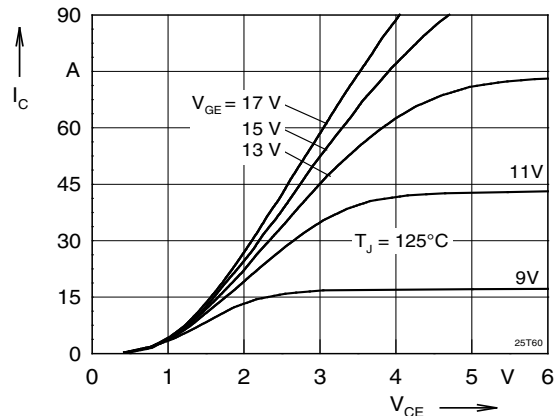

Fig. 2 Typ. output characteristics

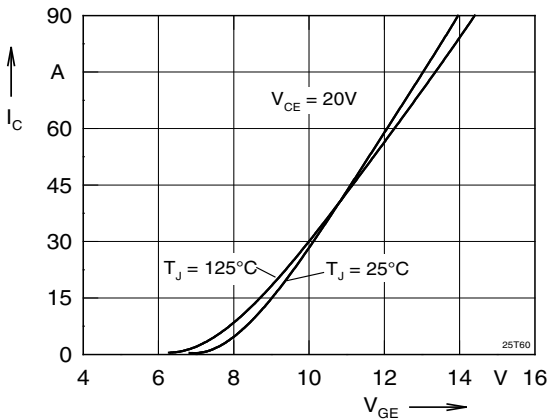

Fig. 3 Typ. transfer characteristics

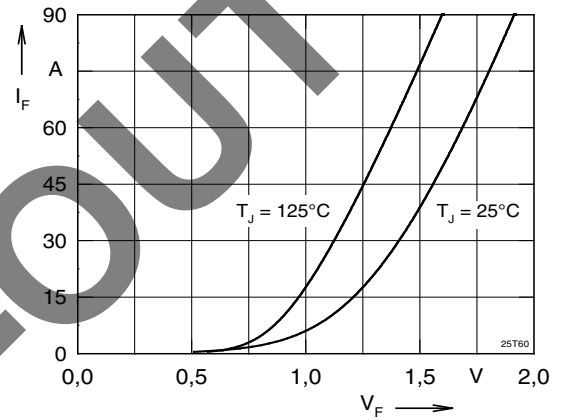

Fig. 4 Typ. forward characteristics of free wheeling diode

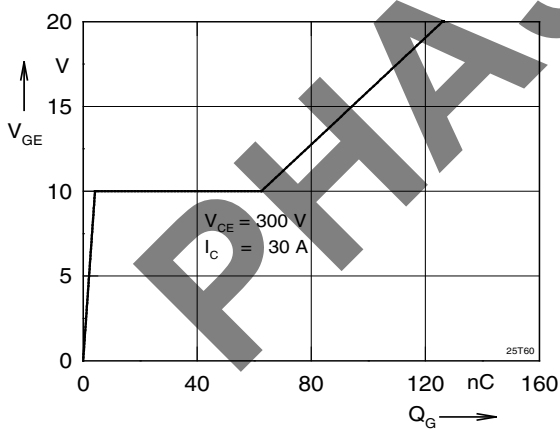

Fig. 5 Typ. turn on gate charge

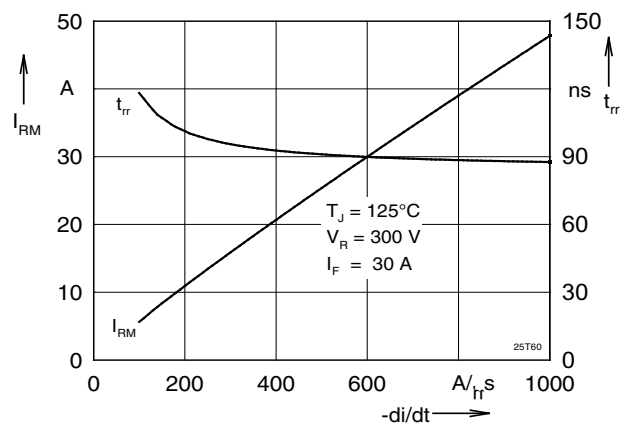

Fig. 6 Typ. turn off characteristics of free wheeling diode

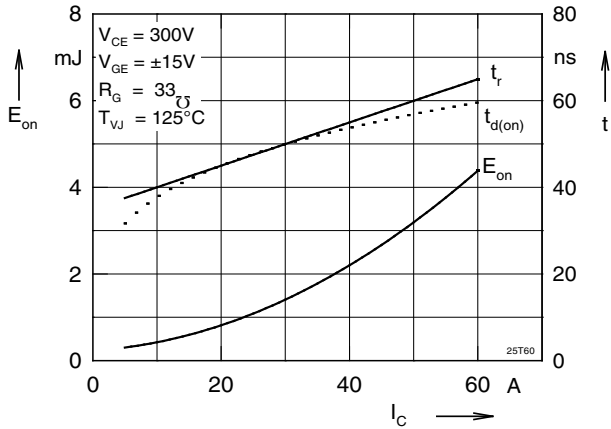

Fig. 7 Typ. turn on energy and switching

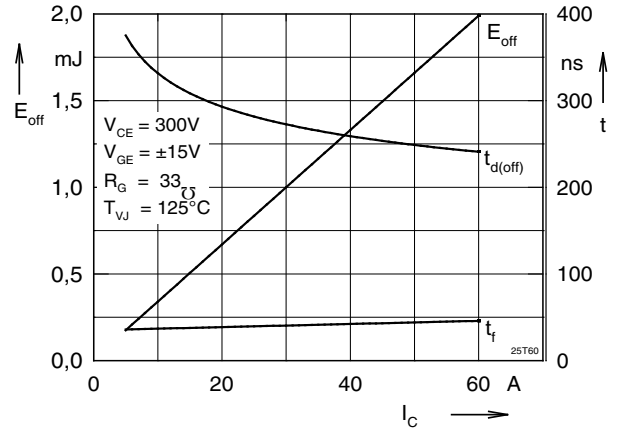

Fig. 8 Typ. turn off energy and switching times versus collector current times versus collector current

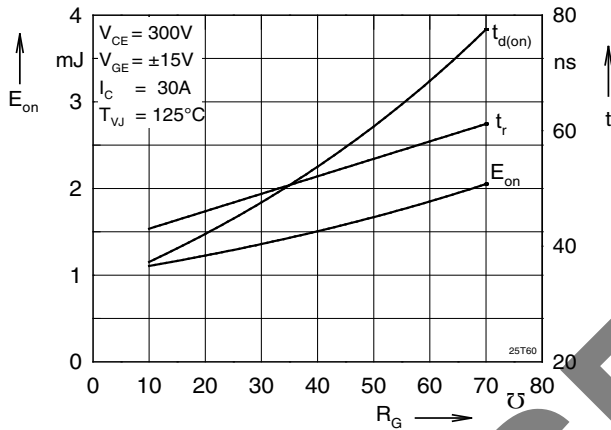

Fig. 9 Typ. turn on energy and switching

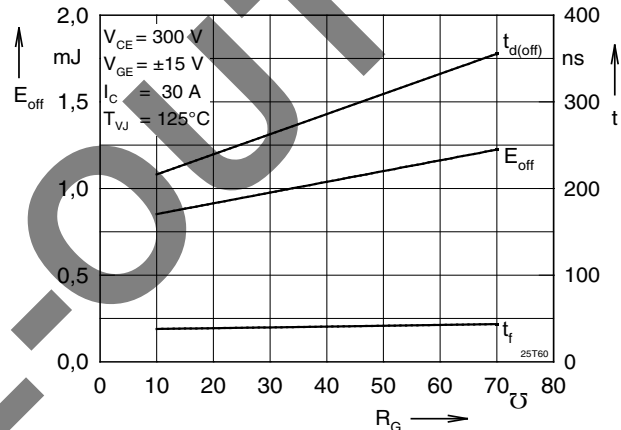

Fig. 10 Typ. turn off energy and switching times versus gate resistor times versus gate resistor

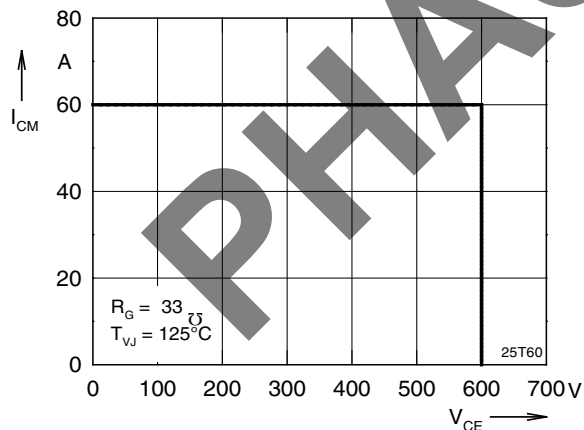

Fig. 11 Reverse biased safe operating area

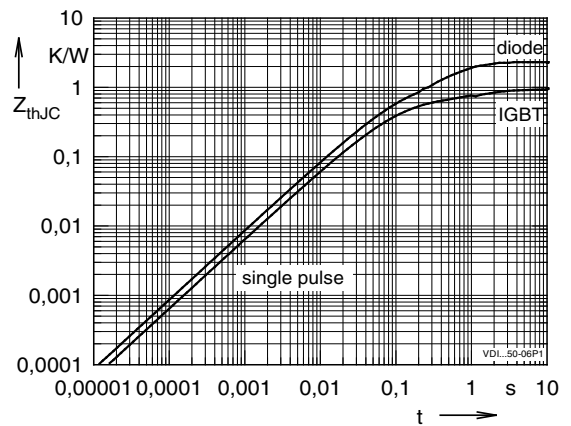

Fig. 12 Typ. transient thermal impedance RBSOA