

High Voltage Thyristor Module

$V_{RRM} = 2200\text{ V}$
 $I_{TAV} = 600\text{ A}$
 $V_T = 1.06\text{ V}$

Single Thyristor

Part number

MCO600-22io1

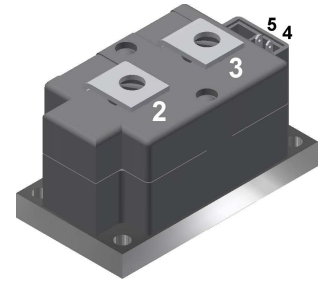

Backside: isolated

E72873

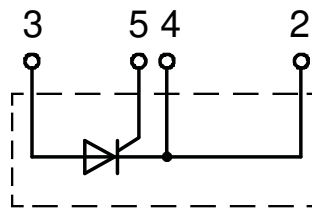

Features / Advantages:

- Thyristor for line frequency
- Planar passivated chip
- Long-term stability
- Direct Copper Bonded Al₂O₃-ceramic

Applications:

- Line rectifying 50/60 Hz
- Softstart AC motor control
- DC Motor control
- Power converter
- AC power control
- Lighting and temperature control

Package: Y1

- Isolation Voltage: 3600 V~
- Industry standard outline
- RoHS compliant
- Soldering pins for PCB mounting
- Base plate: Copper internally DCB isolated
- Advanced power cycling

Terms and Conditions of Usage

The data contained in this product data sheet is exclusively intended for technically trained staff. The user will have to evaluate the suitability of the product for the intended application and the completeness of the product data with respect to his application. The specifications of our components may not be considered as an assurance of component characteristics. The information in the valid application- and assembly notes must be considered. Should you require product information in excess of the data given in this product data sheet or which concerns the specific application of your product, please contact your local sales office.

Due to technical requirements our product may contain dangerous substances. For information on the types in question please contact your local sales office.

Should you intend to use the product in aviation, in health or life endangering or life support applications, please notify. For any such application we urgently recommend

- to perform joint risk and quality assessments;

- the conclusion of quality agreements;

- to establish joint measures of an ongoing product survey, and that we may make delivery dependent on the realization of any such measures.

Thyristor			Ratings			
Symbol	Definition	Conditions	min.	typ.	max.	Unit
$V_{RSM/DSM}$	max. non-repetitive reverse/forward blocking voltage	$T_{VJ} = 25^{\circ}C$			2300	V
$V_{RRM/DRM}$	max. repetitive reverse/forward blocking voltage	$T_{VJ} = 25^{\circ}C$			2200	V
I_{RD}	reverse current, drain current	$V_{R/D} = 2200 V$	$T_{VJ} = 25^{\circ}C$		2	mA
		$V_{R/D} = 2200 V$	$T_{VJ} = 125^{\circ}C$		40	mA
V_T	forward voltage drop	$I_T = 600 A$	$T_{VJ} = 25^{\circ}C$		1.12	V
		$I_T = 1200 A$			1.34	V
		$I_T = 600 A$	$T_{VJ} = 125^{\circ}C$		1.06	V
		$I_T = 1200 A$			1.33	V
I_{TAV}	average forward current	$T_C = 85^{\circ}C$	$T_{VJ} = 140^{\circ}C$		600	A
$I_{T(RMS)}$	RMS forward current	180° sine			940	A
V_{T0}	threshold voltage	} for power loss calculation only	$T_{VJ} = 140^{\circ}C$		0.81	V
r_T	slope resistance				0.4	mΩ
R_{thJC}	thermal resistance junction to case				0.065	K/W
R_{thCH}	thermal resistance case to heatsink			0.02		K/W
P_{tot}	total power dissipation		$T_C = 25^{\circ}C$		1770	W
I_{TSM}	max. forward surge current	$t = 10 \text{ ms}; (50 \text{ Hz}), \text{ sine}$	$T_{VJ} = 45^{\circ}C$		15.0	kA
		$t = 8,3 \text{ ms}; (60 \text{ Hz}), \text{ sine}$	$V_R = 0 V$		16.2	kA
		$t = 10 \text{ ms}; (50 \text{ Hz}), \text{ sine}$	$T_{VJ} = 140^{\circ}C$		12.8	kA
		$t = 8,3 \text{ ms}; (60 \text{ Hz}), \text{ sine}$	$V_R = 0 V$		13.8	kA
I^2t	value for fusing	$t = 10 \text{ ms}; (50 \text{ Hz}), \text{ sine}$	$T_{VJ} = 45^{\circ}C$		1.13	MA ² s
		$t = 8,3 \text{ ms}; (60 \text{ Hz}), \text{ sine}$	$V_R = 0 V$		1.09	MA ² s
		$t = 10 \text{ ms}; (50 \text{ Hz}), \text{ sine}$	$T_{VJ} = 140^{\circ}C$		812.8	kA ² s
		$t = 8,3 \text{ ms}; (60 \text{ Hz}), \text{ sine}$	$V_R = 0 V$		788.8	kA ² s
C_J	junction capacitance	$V_R = 700 V \quad f = 1 \text{ MHz}$	$T_{VJ} = 25^{\circ}C$		469	pF
P_{GM}	max. gate power dissipation	$t_p = 30 \mu s$	$T_C = 140^{\circ}C$		120	W
		$t_p = 300 \mu s$			60	W
P_{GAV}	average gate power dissipation				20	W
$(di/dt)_{cr}$	critical rate of rise of current	$T_{VJ} = 140^{\circ}C; f = 50 \text{ Hz}$	repetitive, $I_T = 1800 A$		100	A/μs
		$t_p = 200 \mu s; di_G/dt = 1 A/\mu s;$ $I_G = 1 A; V = \frac{2}{3} V_{DRM}$	non-repet., $I_T = 600 A$		500	A/μs
$(dv/dt)_{cr}$	critical rate of rise of voltage	$V = \frac{2}{3} V_{DRM}$	$T_{VJ} = 140^{\circ}C$		1000	V/μs
		$R_{GK} = \infty; \text{method 1 (linear voltage rise)}$				
V_{GT}	gate trigger voltage	$V_D = 6 V$	$T_{VJ} = 25^{\circ}C$		2	V
			$T_{VJ} = -40^{\circ}C$		3	V
I_{GT}	gate trigger current	$V_D = 6 V$	$T_{VJ} = 25^{\circ}C$		300	mA
			$T_{VJ} = -40^{\circ}C$		400	mA
V_{GD}	gate non-trigger voltage	$V_D = \frac{2}{3} V_{DRM}$	$T_{VJ} = 140^{\circ}C$		0.25	V
I_{GD}	gate non-trigger current				10	mA
I_L	latching current	$t_p = 30 \mu s$	$T_{VJ} = 25^{\circ}C$		400	mA
		$I_G = 1 A; di_G/dt = 1 A/\mu s$				
I_H	holding current	$V_D = 6 V \quad R_{GK} = \infty$	$T_{VJ} = 25^{\circ}C$		300	mA
t_{gd}	gate controlled delay time	$V_D = \frac{1}{2} V_{DRM}$	$T_{VJ} = 25^{\circ}C$		2	μs
		$I_G = 1 A; di_G/dt = 1 A/\mu s$				
t_q	turn-off time	$V_R = 100 V; I_T = 600 A; V = \frac{2}{3} V_{DRM}$ $di/dt = 10 A/\mu s \quad dv/dt = 50 V/\mu s \quad t_p = 200 \mu s$	$T_{VJ} = 125^{\circ}C$		350	μs

Package Y1			Ratings			
Symbol	Definition	Conditions	min.	typ.	max.	Unit
I_{RMS}	RMS current	per terminal			600	A
T_{VJ}	virtual junction temperature		-40		140	°C
T_{op}	operation temperature		-40		125	°C
T_{stg}	storage temperature		-40		125	°C
Weight				650		g
M_D	mounting torque		4.5		7	Nm
M_T	terminal torque		11		13	Nm
$d_{Spp/App}$	creepage distance on surface striking distance through air	terminal to terminal	16.0			mm
$d_{Spb/Apb}$		terminal to backside	25.0			mm
V_{ISOL}	isolation voltage	t = 1 second	3600			V
		t = 1 minute	3000			V

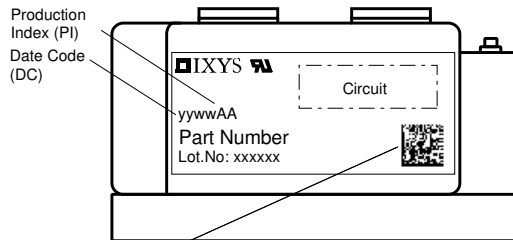

Data Matrix: part no. (1-19), DC + PI (20-25), lot.no.# (26-31), blank (32), serial no.# (33-36)

Ordering	Ordering Number	Marking on Product	Delivery Mode	Quantity	Code No.
Standard	MCO600-22io1	MCO600-22io1	Box	2	474339

Equivalent Circuits for Simulation
** on die level*
 $T_{VJ} = 140\text{ °C}$

Thyristor

$V_{0\ max}$	threshold voltage	0.81	V
$R_{0\ max}$	slope resistance *	0.22	mΩ

Outlines Y1

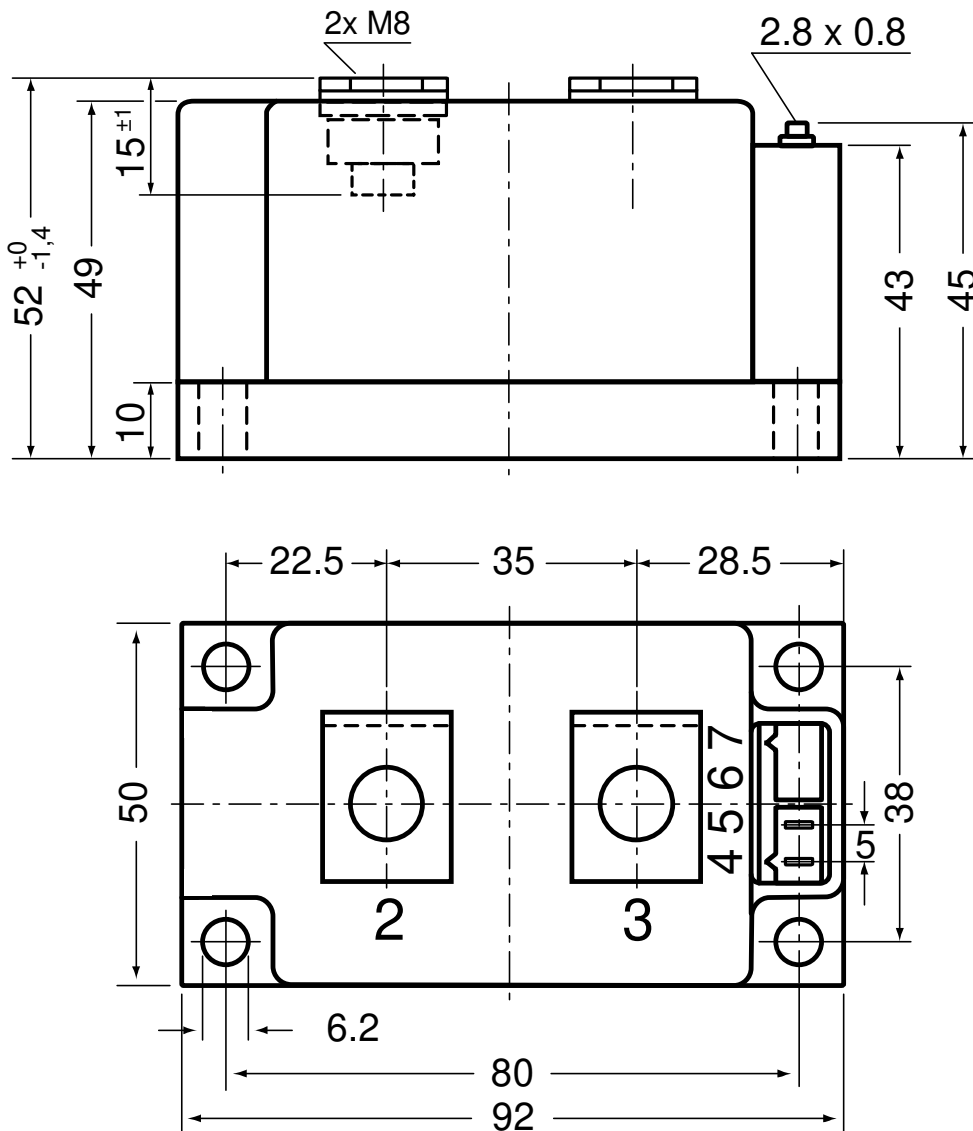

Optional accessories for modules

Keyed gate/cathode twin plugs with wire length = 350 mm, gate = white, cathode = red
 Type ZY 180L (L = Left for pin pair 4/5) UL 758, style 3751

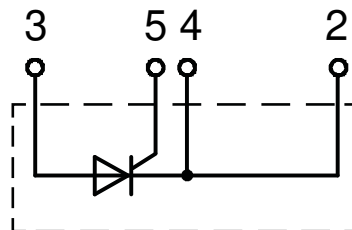

Thyristor

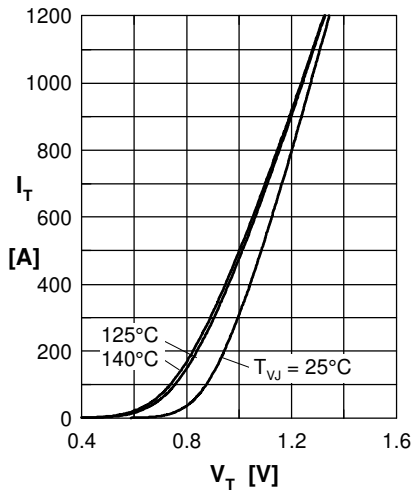

Fig. 1 Forward characteristics

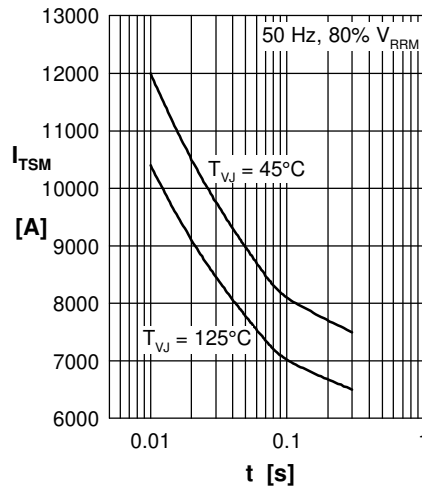

Fig. 2 Surge overload current

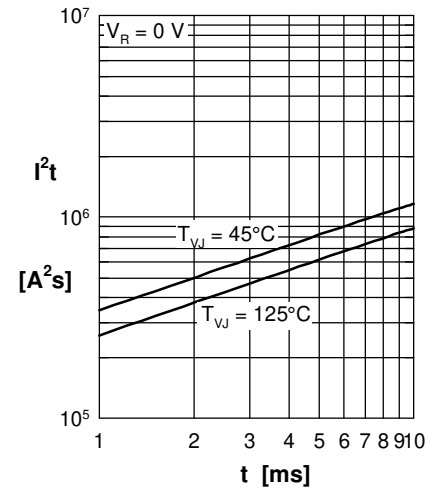

Fig. 3 I^2t versus time (1-10 ms)

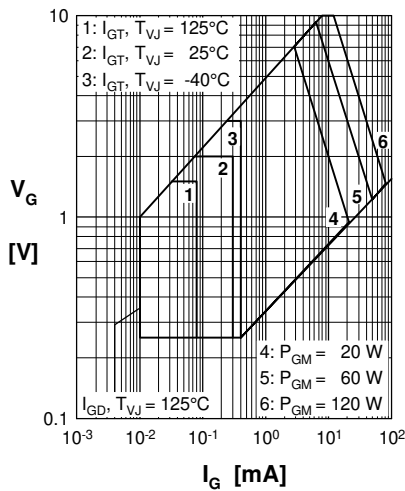

Fig. 4 Gate trigger characteristics

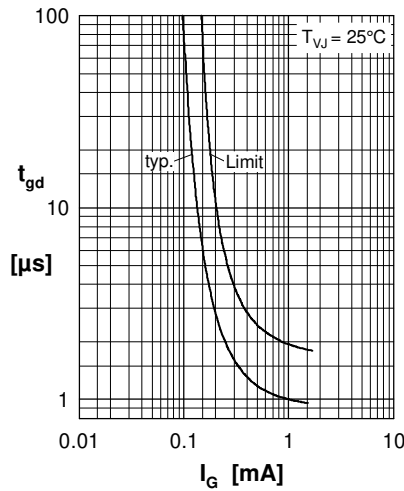

Fig. 5 Gate controlled delay time

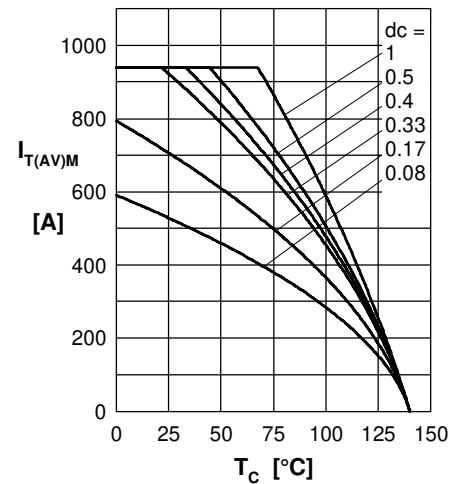

Fig. 6 Max. forward current at case temperature

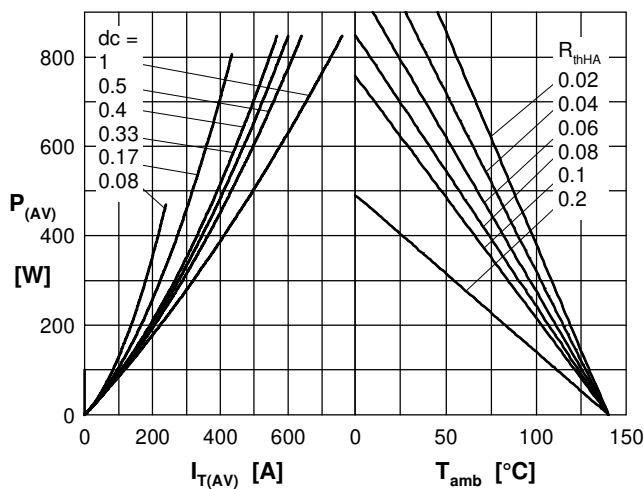

Fig. 7a Power dissipation versus direct output current
Fig. 7b and ambient temperature

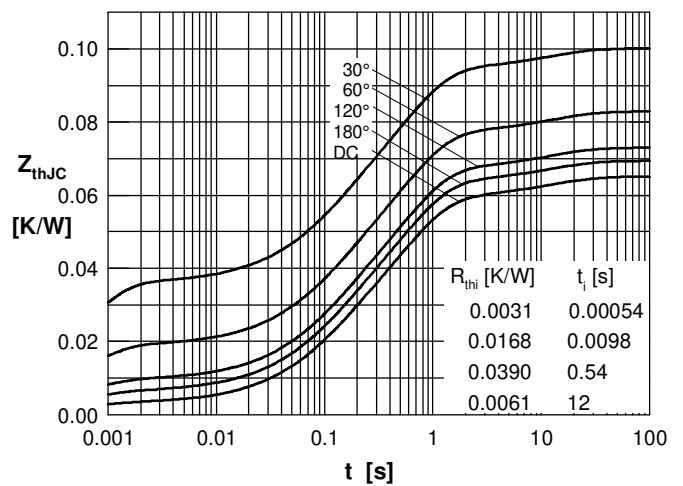

Fig. 8 Transient thermal impedance